

FAN1539B / FAN1540B 1A/1.3A, LDO with Low Quiescent Current

Features

- Very Low Ground Current ($I_{GND} = 1mA$)
- Excellent Line Regulation
- Excellent Load Regulation
- Very Low Transient Overshoot
- Stable with Low-ESR Output Capacitor
- Thermal Shutdown
- Current Limit

Applications

- Disk Drive Circuits
- Desktop Computers
- Laptops, Notebook Computers
- General-Purpose, Three-Terminal Regulators

Description

The FAN1539B / FAN1540B series of high-current LDOs (1.0A and 1.3A) has been developed for portable applications where low quiescent current is an important requirement. The device features excellent line and load transient response that does not exceed 10% of nominal output value for full operating temperature range, even during power ON cycle and short-circuit removal. Internally trimmed, temperature-compensated bandgap reference guarantees 2.5% accuracy for full range of input voltage, output current, and temperature. Included on the chip are accurate current limit and thermal shutdown protection. Device stability is achieved with only two external, low-ESR ceramic capacitors.

The FAN1539B / FAN1540B is available in the thermally enhanced 3x3mm 6-lead MLP package.

Ordering Information

Part Number	Pb-Free	Output Voltage	Package	Packing Method
FAN1539BMPX	Yes	3.3V	3x3mm 6-Lead Molded Leadless Package	Tape and Reel
FAN1540BMPX	Yes	3.3V	3x3mm 6-Lead Molded Leadless Package	Tape and Reel

Tape and Reel Information

Quantity	Reel Size	Width
3000	7 inch	8mm

Block Diagram

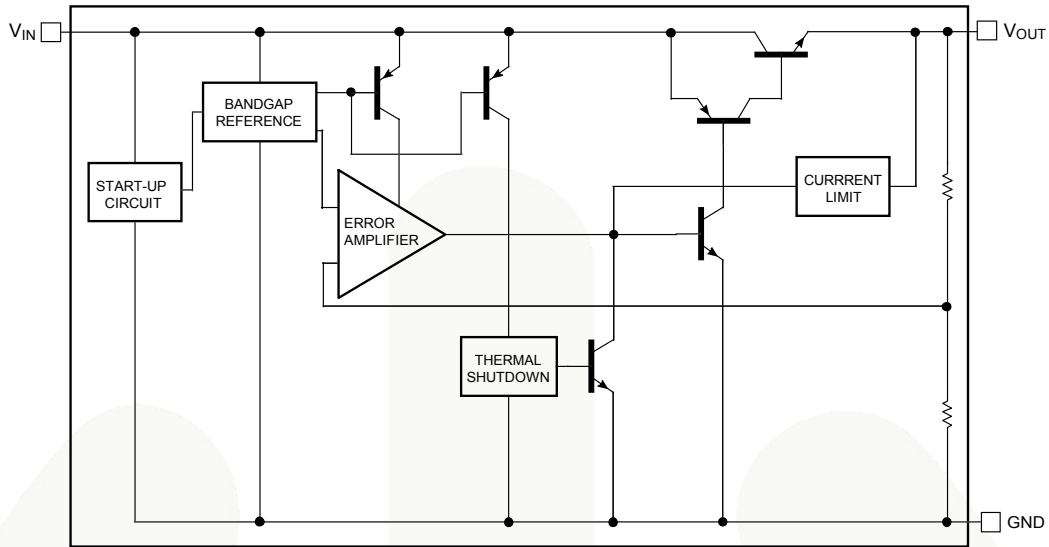

Figure 1. Block Diagram

Pin Configuration

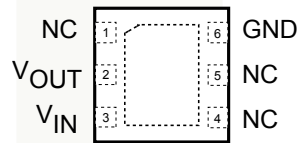
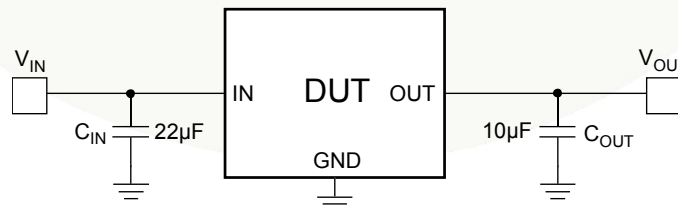

Figure 2. 6-Lead, 3x3mm MLP(Top View)

Pin Definitions

Name	Description
V_{IN}	Input pin.
GND	Ground Pin (Tab).
V_{OUT}	Output pin: Fixed Output Voltage.
NC	No Connection.

Test Circuit



- Notes: 1. Use low-ESR capacitors.
2. C_{IN} should be placed as close to V_{IN} as possible.

Figure 3. Test Circuit

Absolute Maximum Ratings

Stresses exceeding the absolute maximum ratings may damage the device. The device may not function or be operable above the recommended operating conditions and stressing the parts to these levels is not recommended. In addition, extended exposure to stresses above the recommended operating conditions may affect device reliability. The absolute maximum ratings are stress ratings only.

Symbol	Parameter		Value	Unit
V_{IN}	Operating Input Voltage		10	V
P_D	Power Dissipation		Internally Limited	W
I_{OSH}	Short-Circuit Output Current		Internally Limited	A
T_J	Operating Junction Temperature Range		0 to 150	°C
θ_{JC}	Thermal Resistance—Junction to Tab ⁽¹⁾		8	°C/W
T_{STG}	Storage Temperature Range ⁽¹⁾		-65 to 150	°C
T_L	Lead Temperature ⁽²⁾	I.R. Reflow 30 seconds	240	°C
		Soldering 10 seconds	260	°C
ESD	Electrostatic Discharge Protection ⁽³⁾	Human Body Model	4	kV
		Charged Device Model	2	

Notes:

1. Junction-to-ambient thermal resistance, θ_{JA} , is a strong function of PCB material, board thickness, thickness and number of copper plains, number of via used, diameter of via used, available copper surface, and attached heat sink characteristics. Thermal resistance (θ_{JA}), V_{IN} , and I_{OUT} must be chosen not to exceed $T_J = 150^\circ\text{C}$.
2. Soldering temperature should be 260°C for 10 seconds after 240°C for 30 seconds in I.R. reflow using 60/40 solder. Maximum rate of temperature rise is 3°C per second to within 100°C of the final temperature.
3. Using Mil Std. 883E, method 3015.7 (Human Body Model) and EIA/JESD22C101-A (Charged Device Model).

tm

Electrical Characteristics

Unless otherwise specified, $V_{IN} = 4.50V$ to $7V$, $T_J = 25^\circ C$, $I_{MAX} = 1.3A$. **Bold** limits apply over operating junction temperature range of $0^\circ C \leq T_J \leq 125^\circ C$.

Symbol	Parameter	Test Conditions		Test Limits			Units
		V_{IN}	I_{OUT}	Min.	Typ.	Max.	
V_{OUT}	Output Voltage	$4.75V \leq V_{IN} \leq 5.25V$	$5mA \leq I_{OUT} \leq I_{MAX}$	3.234 3.217	3.300	3.366 3.383	V
V_{LINE}	Line Regulation	$3.0V \leq V_{IN} \leq 5.25V$	$5mA \leq I_{OUT} \leq I_{MAX}$		2	15	mV
V_{LOAD}	Load Regulation – FAN1539B	4.75V	$5mA \leq I_{OUT} \leq I_{MAX}$		25	35	mV
	Load Regulation – FAN1540B	4.75V	$5mA \leq I_{OUT} \leq I_{MAX}$		30	40	mV
V_D	Dropout Voltage ⁽⁴⁾		$I_{OUT} = I_{MAX}$		0.9	1.2	V
I_S	Current Limit	5.5V			3.3		A
I_{OMIN}	Minimum Output Current for Regulation ($\Delta V_{OUT} \leq 3\%$)			0			mA
T_S	Temperature Stability		$I_{OUT} = 5mA$		0.3		%
V_N	RMS Output Noise ⁽⁵⁾		$I_{OUT} = I_{MAX}$		0.003		% V_{OUT}
R_A	Ripple Rejection Ratio ⁽⁶⁾	5V	$I_{OUT} = 10mA$	65	75		dB
			$I_{OUT} = 100mA$	63	73		
			$I_{OUT} = I_{MAX}$	45	57		
$\frac{\Delta V_{OUT}}{\Delta I_{OUT}}$	Transient Response Change of V_{OUT} with Step Load Change ⁽⁷⁾	5V	$1mA$ to I_{MAX} $t_r \geq 1\mu s$		2.0	10 (undershoot or overshoot of V_{OUT})	%
	Transient Response Change of V_{OUT} with Application of V_{IN} ⁽⁷⁾	0 to 5V Step Input $t_r \geq 1\mu s$ 10% to 90%	$1mA \leq I_{OUT} \leq I_{MAX}$		5.0	10 (undershoot or overshoot of V_{OUT})	
	Transient Response Short-Circuit Removal Response ⁽⁷⁾	5V	$I_{OUT} = \text{short to } I_{OUT} = 10mA$		5.0	10 (undershoot or overshoot of V_{OUT})	
I_Q	Quiescent Current	$V_{IN} \leq 7V$	$I_{OUT} = 0mA$		1.0	2.0	mA
		$V_{IN} \leq 7V$	$2mA \leq I_{OUT} \leq I_{MAX}$		1.0	2.0	mA
		$V_{IN} = 5V$	$0mA \leq I_{OUT} \leq 50mA$		1.0	2.0	mA
T_{SD}	Thermal Shutdown	$3.0V \leq V_{IN} \leq 5.25V$			160		$^\circ C$
T_{HYS}	Thermal Hysteresis	$3.0V \leq V_{IN} \leq 5.25V$			15		$^\circ C$

Notes:

- Dropout voltage is defined as the input to output differential voltage at which the output voltage drops 1% below the nominal value measured at $V_{IN} = 5V$.
- Measured within 10Hz to 10kHz bandwidth.
- Measured at DC, specified at 120Hz.
- $C_{IN} = 22\mu F$, $C_{OUT} = 10\mu F$. Both capacitors are low-ESR X7R type.

Typical Performance Characteristics

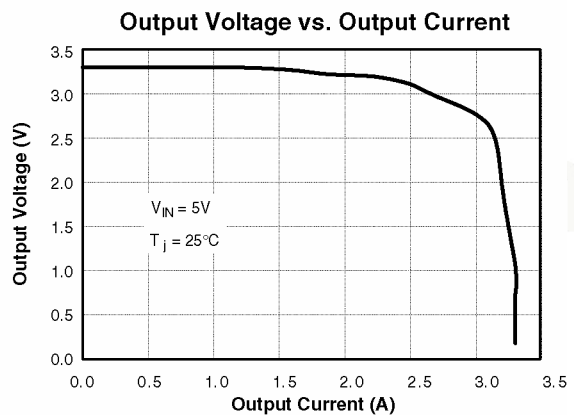
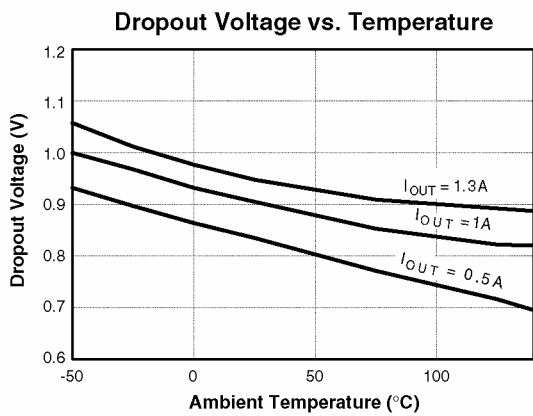
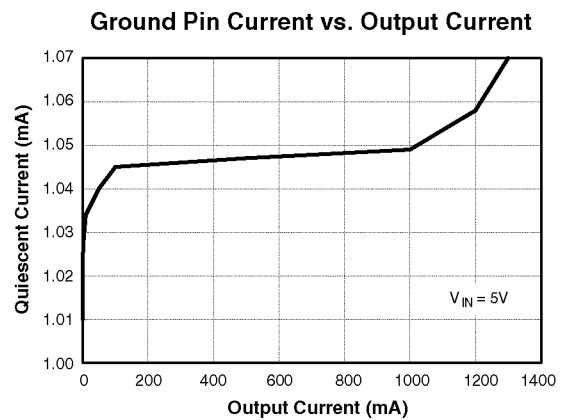
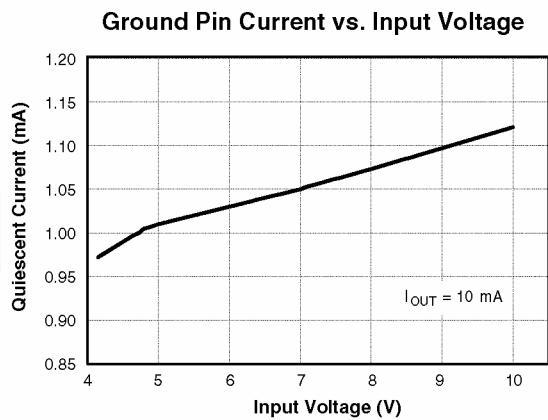
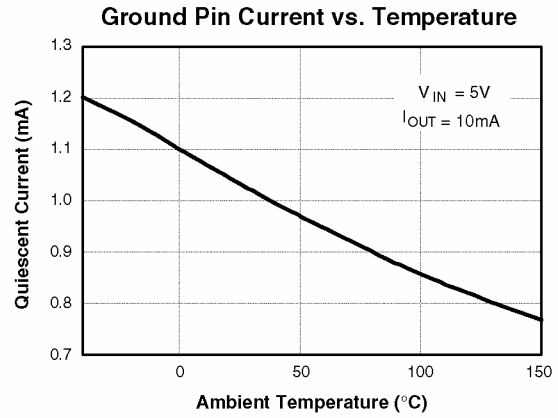
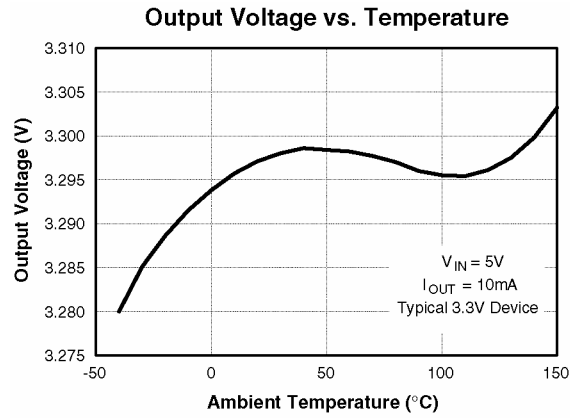

Typical Performance Characteristics (Continued)

Line Transient Response

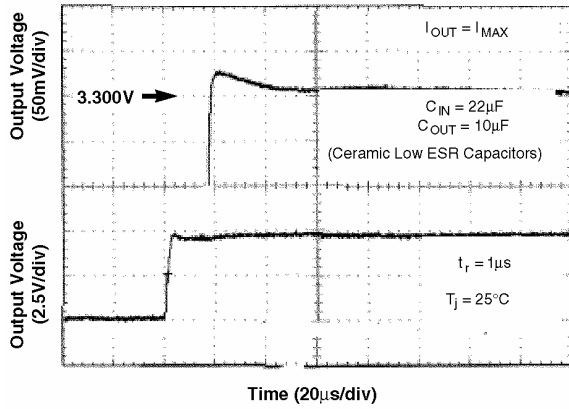

Load Transient Response

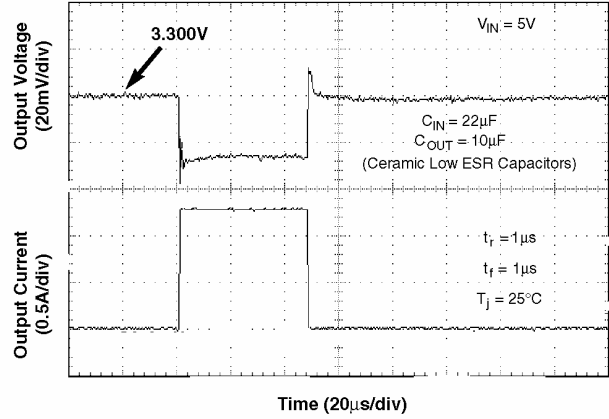

Short Circuit Removal Response

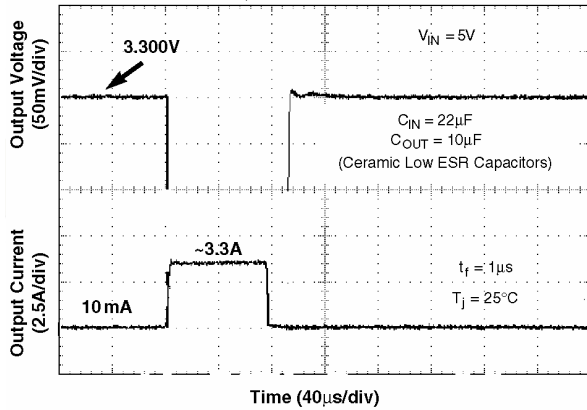

Ripple Rejection vs. Frequency

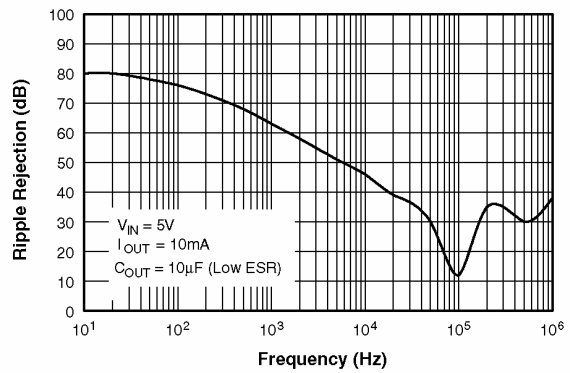

Output Spectral Noise Density vs. Frequency

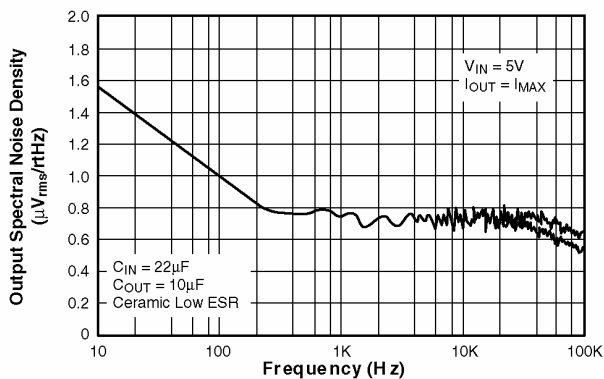

Typical Region of Stability ESR vs. Output Current*

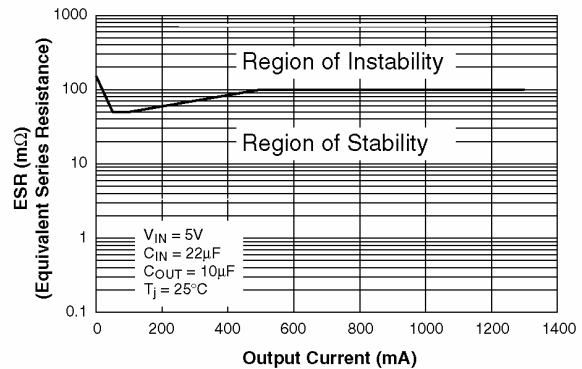

*Note: ESR Values measured at $f = 10kHz$

Note:

- Transient response tests require short lead lengths and low-resistance connections at source and load.

Applications Information

General Circuit Description

The FAN1539B / FAN1540B is an advanced low-dropout voltage regulator specially designed for applications in portable computers, where high performance and low quiescent current are required. The device has an internal trimmed bandgap voltage reference and an internal output voltage sense divider. These two signals form the input to the error amplifier that regulates the output voltage.

The FAN1539B / FAN1540B has a set of internal protection circuitry, including thermal shutdown, short-circuit current limit, and electrostatic discharge protection. Low-ESR ceramic capacitors are needed for input as well as output pins to maintain the circuit stability.

Short-Circuit Current Limit

The device has internal over-current limit and short-circuit protection. Under over-current conditions, the device current is determined by the current-limit threshold. Once the device is released from short-circuit conditions, the normal level of current limit is gradually re-established as the device output voltage reaches normal levels. Special circuitry has been added to ensure that recovery from short-circuit current conditions does not lead to excessive overshoot of the output voltage — a phenomenon often encountered in conventional regulators.

Thermal Protection

The FAN1539B / FAN1540B is designed to supply at least 1A/1.3A output current. Excessive output load at high input-output voltage difference causes the device temperature to increase and exceed maximum ratings due to power dissipation. During output overload conditions, if the die temperature exceeds the shutdown limit temperature of 160°C, an onboard thermal protection disables the output until the temperature drops approximately 15°C below the limit; at which point, the output is re-enabled.

Thermal Characteristics

The FAN1539/FAN1539B / FAN1540B is designed to supply at least 1A/1.3A at the specified output voltage, with an operating die (junction) temperature of up to 125°C. Once the power dissipation and thermal resistance are known, the maximum junction temperature of the device can be calculated. While the power dissipation is calculated from known electrical parameters, the actual thermal resistance depends on the thermal characteristics of the chosen package and the surrounding PC board copper to which it is mounted.

The power dissipation is equal to the product of the input-to-output voltage differential and the output current, plus the ground current, multiplied by the input voltage:

$$P_D = (V_{IN} - V_{OUT})I_{OUT} + V_{IN}I_{GND} \quad \text{EQ. 1}$$

The ground pin current, I_{GND} can be found in the Electrical Characteristics tables.

The relationship describing the thermal behavior of the package is:

$$P_{D(\max)} = \left\{ \frac{T_{J(\max)} - T_A}{\theta_{JA}} \right\} \quad \text{EQ. 2}$$

where $T_{J(\max)}$ is the maximum allowable junction temperature of the die, which is 150°C, and T_A is the ambient operating temperature. θ_{JA} is dependent on the surrounding PC board layout and can be empirically obtained. While the θ_{JC} (junction-to-case) of the 6-lead MLP package is specified at 8°C/W, the θ_{JA} for a minimum PWB footprint is substantially higher. This can be improved by providing a heat sink of surrounding copper ground on the PWB. Depending on the size of the copper area and the thickness of the copper layer, the resulting θ_{JA} can vary over a wide range. The addition of backside copper with through-holes, stiffeners, and other enhancements can also reduce thermal resistance.

Thermal simulations performed on a thermally optimized board layout indicate that θ_{JA} as low as 20°C/W can be achieved.

The heat contributed by the dissipation of other devices located nearby must be included in the design considerations. Overload conditions also need to be considered. It is possible for the device to enter a thermal cycling loop, in which the circuit enters a shutdown condition, cools, re-enables, and then again overheats and shuts down repeatedly due to a persistent fault condition.

Capacitor ESR and PCB Layout

The FAN1539/FAN1539B / FAN1540B has been optimized to accommodate low-ESR bypass capacitors down to less than 0mΩ. For best results, place both input and output bypass capacitors as near to the input and output pins as possible. X7R types are recommended, including Murata's GRM31CR70J106KA01B (10μF) and GRM43ER71A226KE01B (22μF) or similar component from TDK. The capacitors should connect directly to the ground plane. Use of ground plane on the top and the bottom side of the PCB is recommended. As many vias as possible should be used to minimize ground plane resistance.

Physical Dimensions

Dimensions are in millimeters unless otherwise specified.

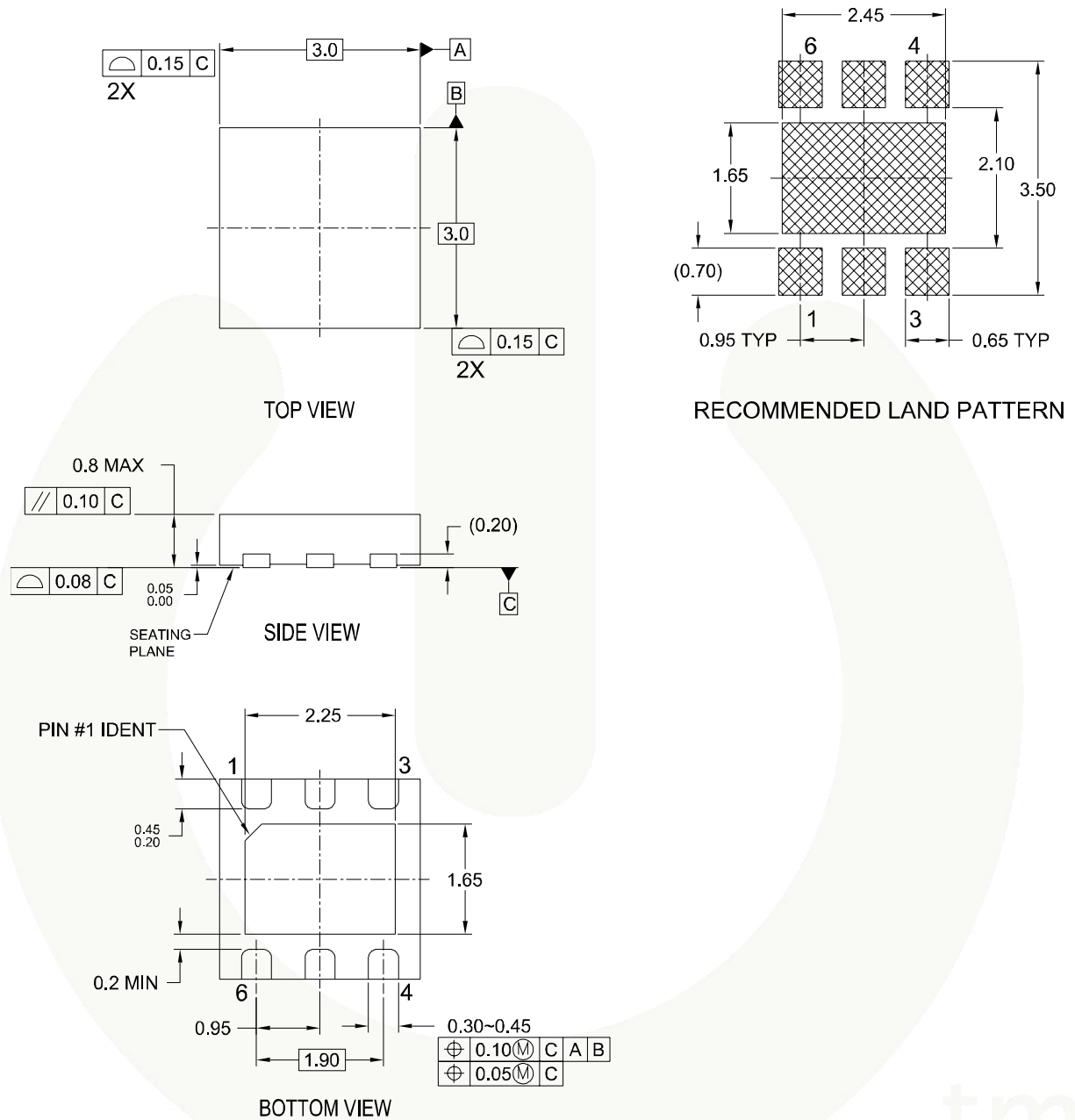

NOTES:

- A. CONFORMS TO JEDEC REGISTRATION MO-229, VARIATION WEEA, DATED 11/2001
- B. DIMENSIONS ARE IN MILLIMETERS.
- C. DIMENSIONS AND TOLERANCES PER ASME Y14.5M, 1994

MLP06DrevA

Figure 4. 3x3mm 6-Lead Molded Leadless Package (MLP)



TRADEMARKS

The following are registered and unregistered trademarks and service marks Fairchild Semiconductor owns or is authorized to use and is not intended to be an exhaustive list of all such trademarks.

ACEX [®]	Green FPS [™] e-Series [™]	POWEREDGE [®]	SuperSOT [™] -8
Build it Now [™]	GTO [™]	Power-SPM [™]	SyncFET [™]
CorePLUS [™]	i-Lo [™]	PowerTrench [®]	The Power Franchise [®]
CROSSVOLT [™]	IntelliMAX [™]	Programmable Active Droop [™]	 ™
CTL [™]	ISOPLANAR [™]	QFET [®]	TinyBoost [™]
Current Transfer Logic [™]	MegaBuck [™]	QS [™]	TinyBuck [™]
EcoSPARK [®]	MICROCOUPLER [™]	QT Optoelectronics [™]	TinyLogic [®]
FACT Quiet Series [™]	MicroFET [™]	Quiet Series [™]	TINYOPTO [™]
FACT [®]	MicroPak [™]	RapidConfigure [™]	TinyPower [™]
FAST [®]	Motion-SPM [™]	SMART START [™]	TinyPWM [™]
FastvCore [™]	OPTOLOGIC [™]	SPM [®]	TinyWire [™]
FPS [™]	OPTOPLANAR [®]	STEALTH [™]	μSerDes [™]
FRFET [®]	PDP-SPM [™]	SuperFET [™]	UHC [®]
Global Power Resource SM	Power220 [®]	SuperSOT [™] -3	UniFET [™]
Green FPS [™]	Power247 [®]	SuperSOT [™] -6	VCX [™]

DISCLAIMER

FAIRCHILD SEMICONDUCTOR RESERVES THE RIGHT TO MAKE CHANGES WITHOUT FURTHER NOTICE TO ANY PRODUCTS HEREIN TO IMPROVE RELIABILITY, FUNCTION, OR DESIGN. FAIRCHILD DOES NOT ASSUME ANY LIABILITY ARISING OUT OF THE APPLICATION OR USE OF ANY PRODUCT OR CIRCUIT DESCRIBED HEREIN; NEITHER DOES IT CONVEY ANY LICENSE UNDER ITS PATENT RIGHTS, NOR THE RIGHTS OF OTHERS. THESE SPECIFICATIONS DO NOT EXPAND THE TERMS OF FAIRCHILD'S WORLDWIDE TERMS AND CONDITIONS, SPECIFICALLY THE WARRANTY THEREIN, WHICH COVERS THESE PRODUCTS.

LIFE SUPPORT POLICY

FAIRCHILD'S PRODUCTS ARE NOT AUTHORIZED FOR USE AS CRITICAL COMPONENTS IN LIFE SUPPORT DEVICES OR SYSTEMS WITHOUT THE EXPRESS WRITTEN APPROVAL OF FAIRCHILD SEMICONDUCTOR CORPORATION.

As used herein:

- Life support devices or systems are devices or systems which, (a) are intended for surgical implant into the body or (b) support or sustain life, and (c) whose failure to perform when properly used in accordance with instructions for use provided in the labeling, can be reasonably expected to result in a significant injury of the user.
- A critical component in any component of a life support device, or system whose failure to perform can be reasonably expected to cause the failure of the life support device or system, or to affect its safety or effectiveness.

PRODUCT STATUS DEFINITIONS

Definition of Terms

Datasheet Identification	Product Status	Definition
Advance Information	Formative or In Design	This datasheet contains the design specifications for product development. Specifications may change in any manner without notice.
Preliminary	First Production	This datasheet contains preliminary data; supplementary data will be published at a later date. Fairchild Semiconductor reserves the right to make changes at any time without notice to improve design.
No Identification Needed	Full Production	This datasheet contains final specifications. Fairchild Semiconductor reserves the right to make changes at any time without notice to improve design.
Obsolete	Not In Production	This datasheet contains specifications on a product that has been discontinued by Fairchild Semiconductor. The datasheet is printed for reference information only.

Rev. I29